

DATE  
Sept. 12, 2005  
CAT. #: HH0052

OUTLINE DIMENSIONS  
3-PHASE INDUCTION MOTOR

MOTOR TYPE:  
AEHH  
FRAME NO. 184T

Pole	HP	kW	Hz	VOLT	Syn. Speed r/min(rpm)
2	5	3.7	60	460	3600

Ins	Rating	Dimension in	Approx Weight	Bearings
F	CONT.	inches	95 lbs.	DE: 6306ZC35C NDE: 6306ZC35C

Totally Enclosed Fan-Cooled Type, Squirrel-Cage Rotor.

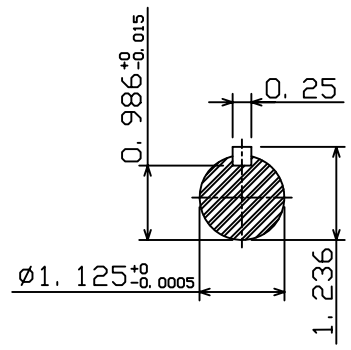
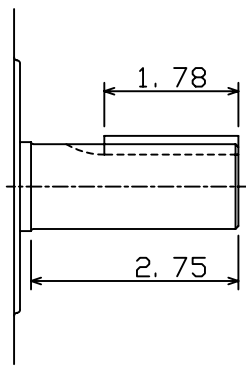
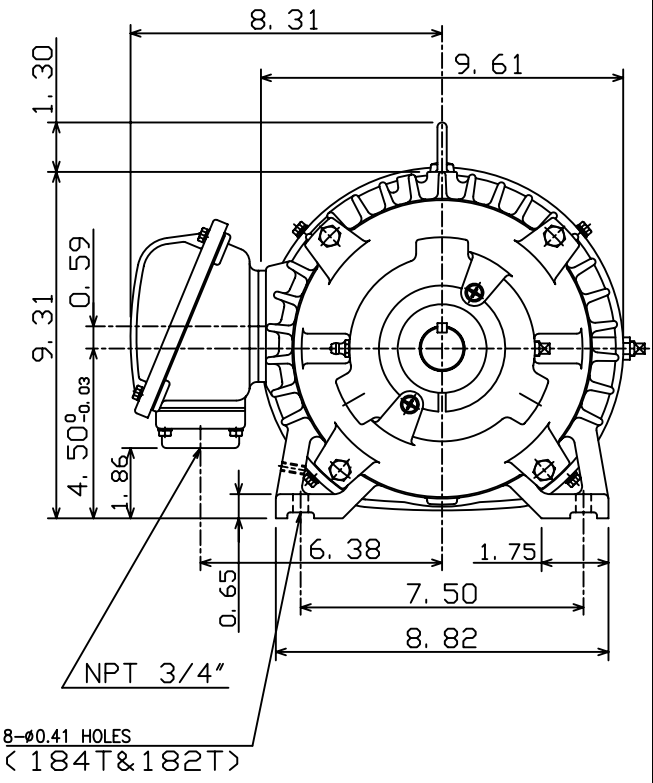
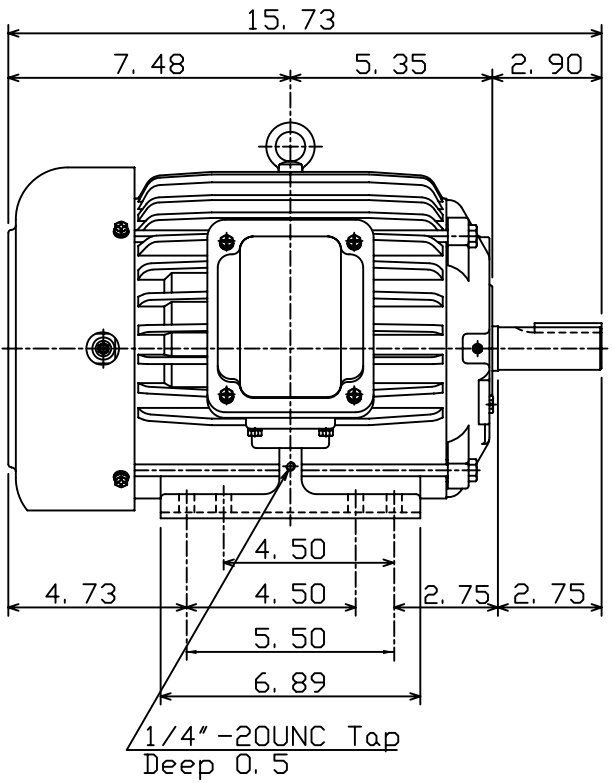

DWN.	C. S. LO	12-22-04
CHKD.	C. S. LO	12-27-04
APPD.	M. C. TSAI	12-27-04



DWG NO.  
31049M892140