

Dimensões em polegada
Dimensions in inches

THIS IS AN UPDATED REVISION, THE
PREVIOUS ONE MUST BE DISREGARDED.

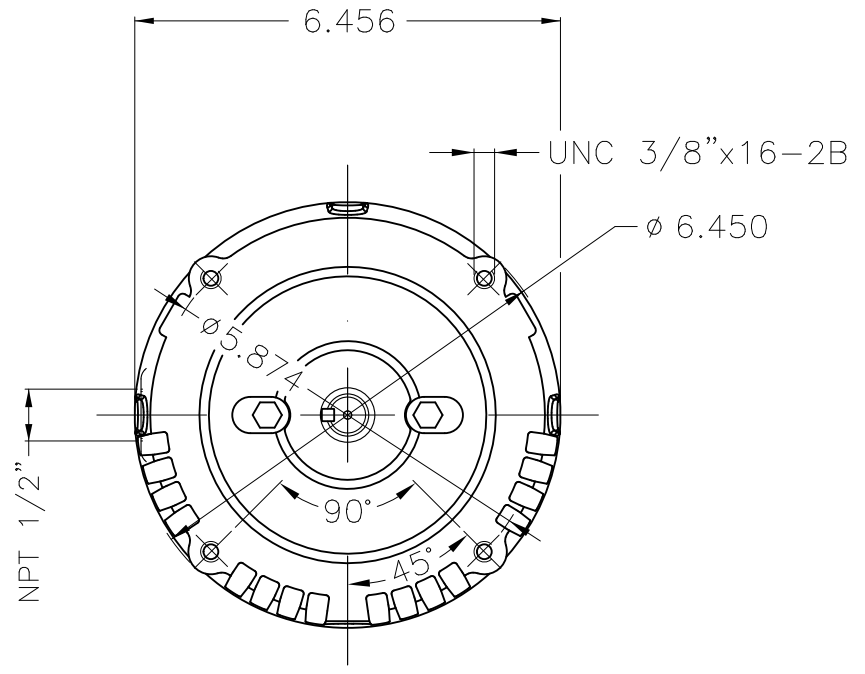

Grounding

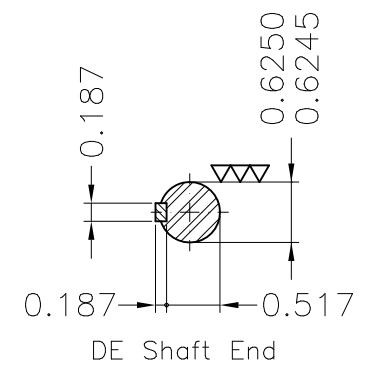
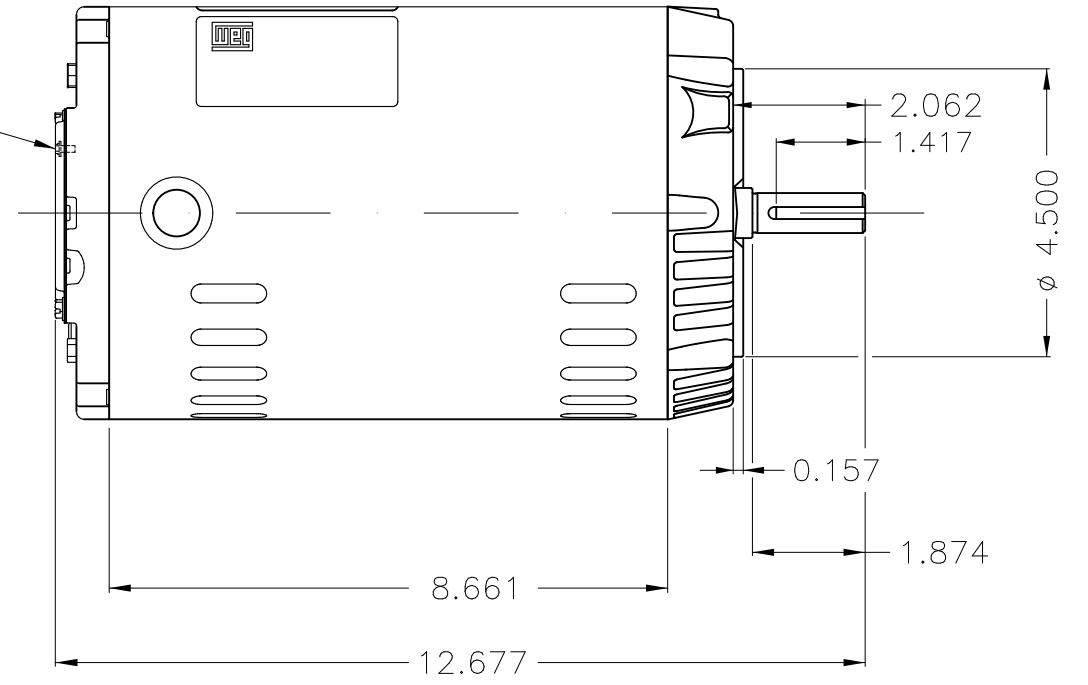

Without coating									
Mounting F-1/B14R(D)									
ECM	LOC	SUMMARY OF MODIFICATIONS			EXECUTED	CHECKED	RELEASED	DATE	VER
EXECUTED	USERADMIN	THREE PHASE ODP ROLLED STEEL PREM. EFF.							
CHECKED		FRAME 56C ODP							
RELEASED		WEG code: 12812242							
REL DT	24.07.2017	WMO	Jaragua do Sul	Product Engineering	SHEET	1 / 1			

2 HP 02 Poles 60Hz

A

