

Dimensões em polegada  
Dimensions in inches

THIS IS AN UPDATED REVISION, THE  
PREVIOUS ONE MUST BE DISREGARDED.

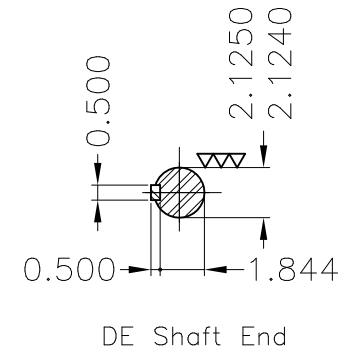
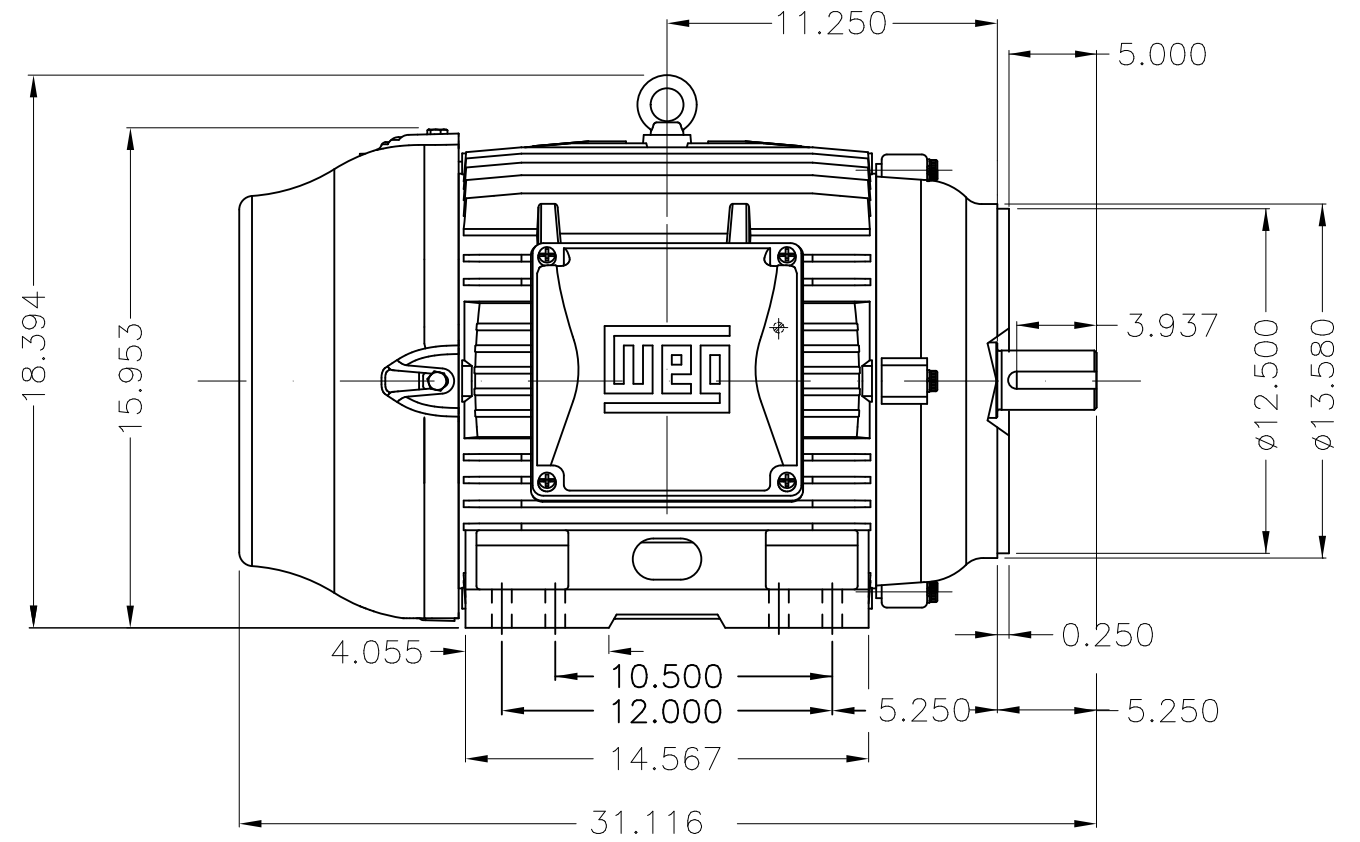
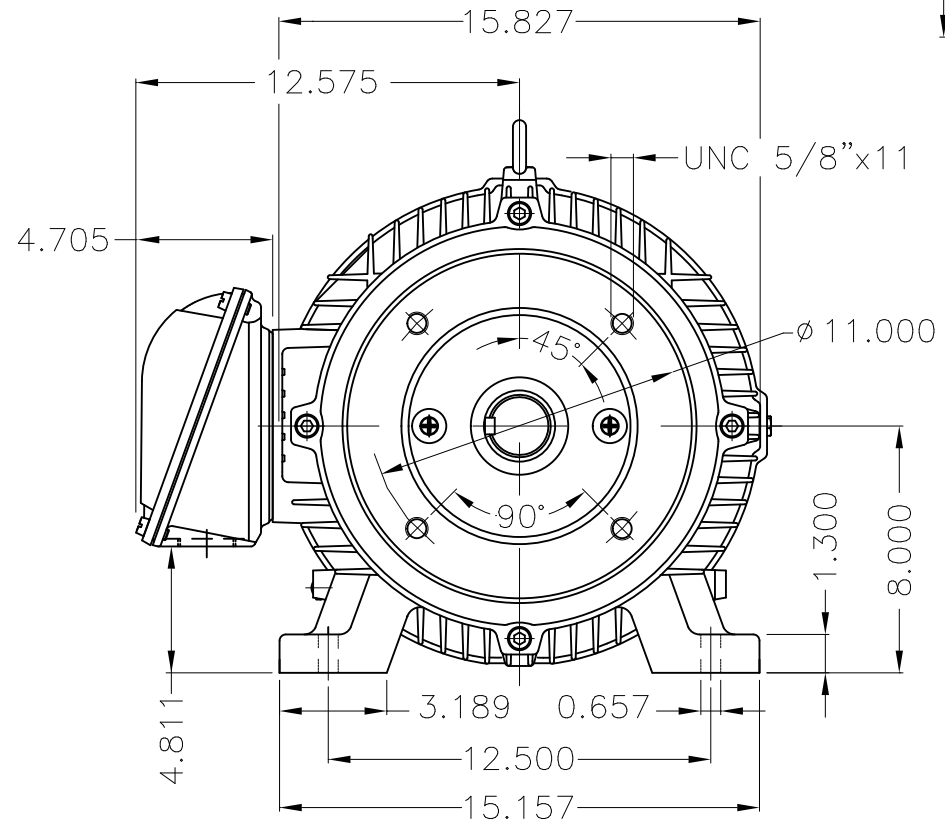
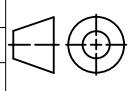

Color RAL 5009  
Painting plan 203A  
Mounting B34R(D)

ECM	LOC	SUMMARY OF MODIFICATIONS			EXECUTED	CHECKED	RELEASED	DATE	VER
EXECUTED	USERADMIN		THREE PHASE W22 MOTOR - NEMA PREMIUM EFF						
CHECKED			FRAME 324/6TC IP55 TEFC						
RELEASED			WEG code: 11556413						
REL DT	24.07.2017	WMO	Jaragua do Sul	Product Engineering	SHEET	1 / 1			

50 HP 04 Poles 60Hz

