

Dimensões em polegada
Dimensions in inches

THIS IS AN UPDATED REVISION, THE
PREVIOUS ONE MUST BE DISREGARDED.

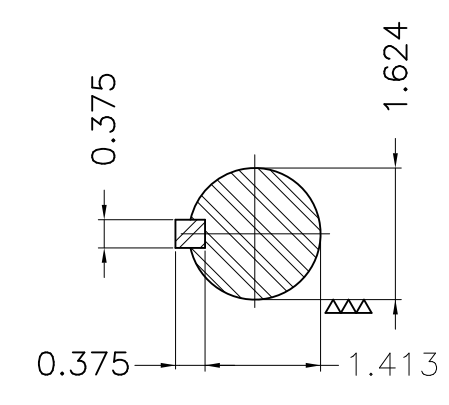
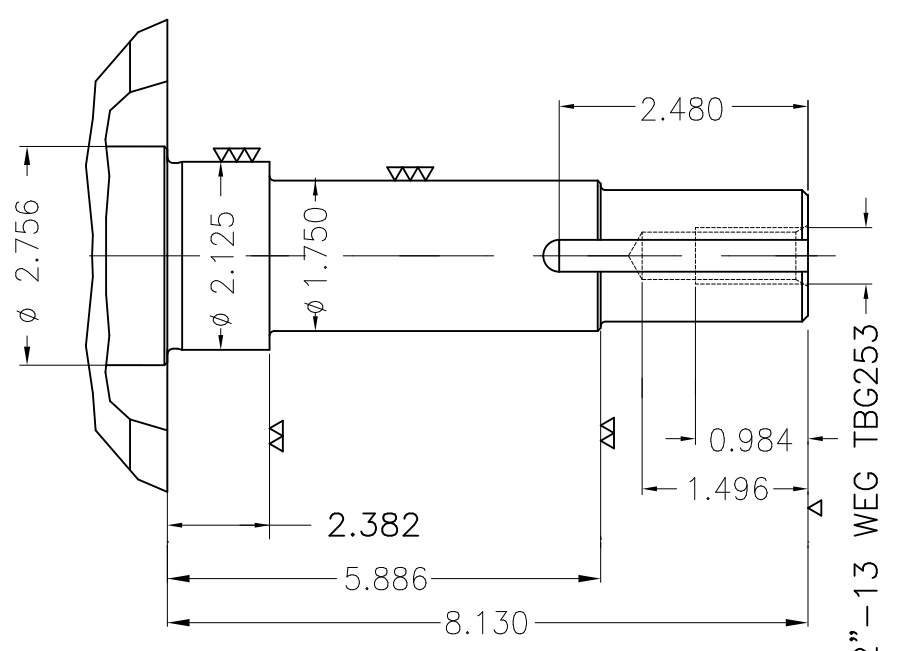
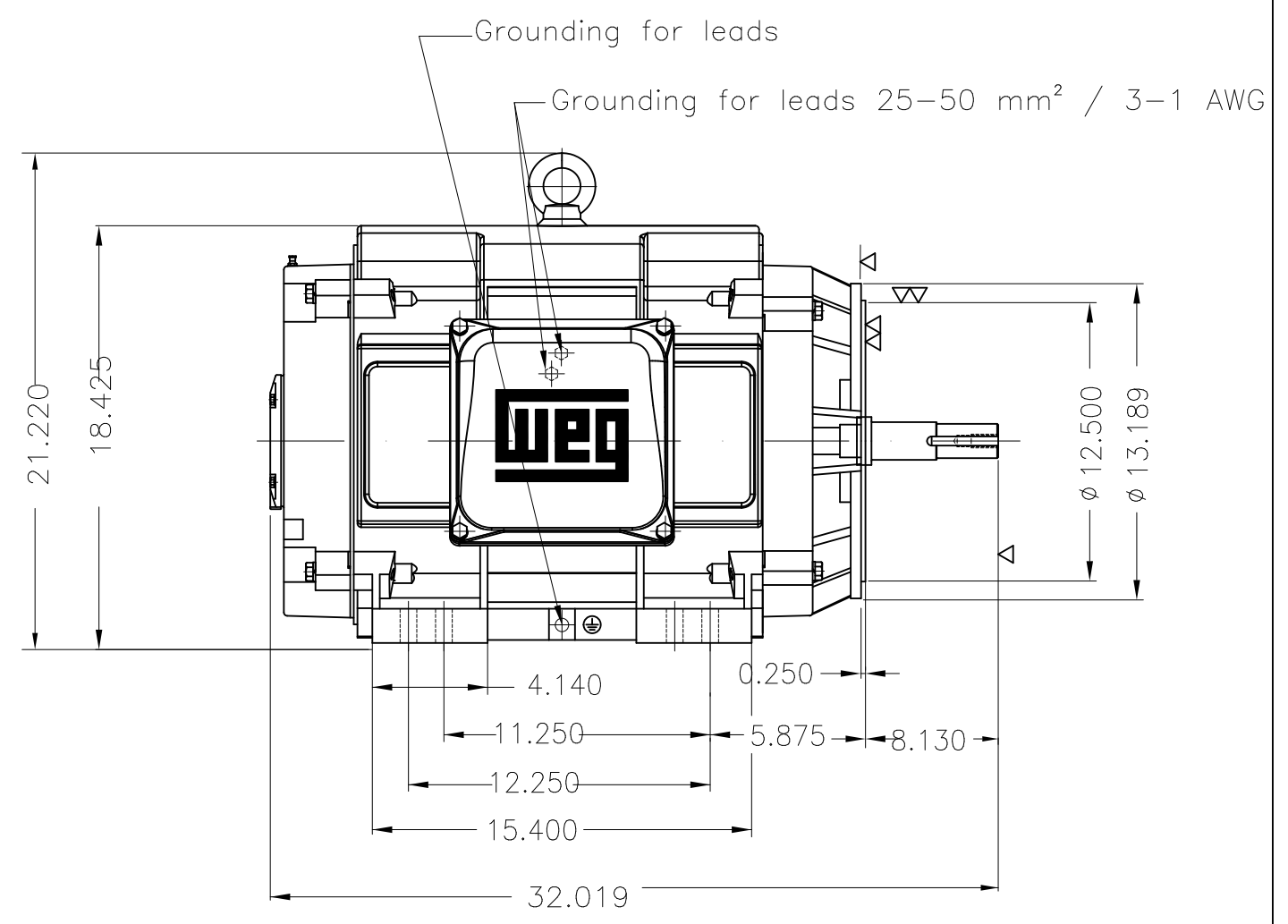
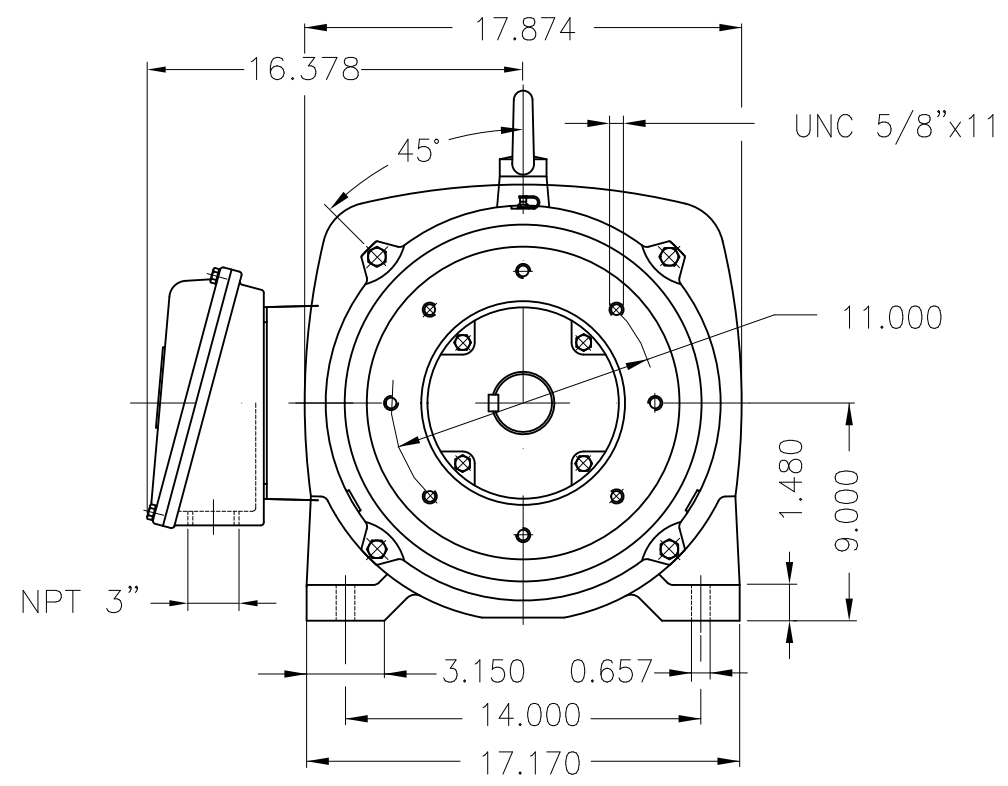

Color RAL 5009
Painting plan 203A
Mounting B34R(D)

ECM	LOC	SUMMARY OF MODIFICATIONS	EXECUTED	CHECKED	RELEASED	DATE	VER
EXECUTED	USERADMIN	THREE PHASE MOTOR JP NEMA PREMIUM EFF.					
CHECKED		FRAME 364/5JP IP23 ODP					
RELEASED		WEG code: 11263079					
REL DT	24.07.2017	WMO Jaraguá do Sul	Product Engineering	SHEET	1 / 1		

100 HP 02 Poles 60Hz

