

Dimensões em mm
Dimensions in mm

THIS IS AN UPDATED REVISION, THE
PREVIOUS ONE MUST BE DISREGARDED.

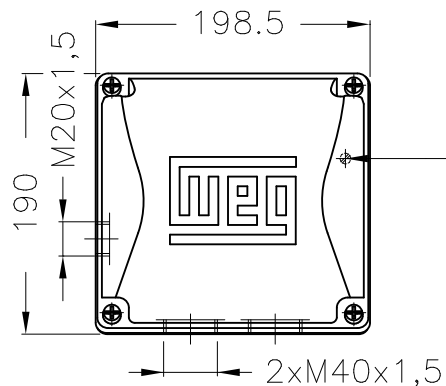
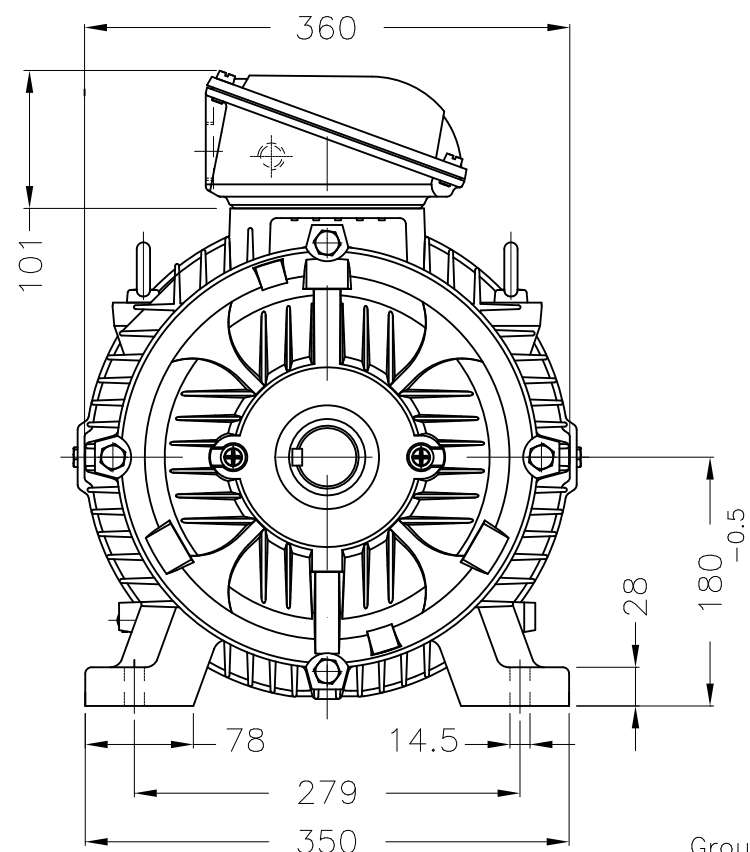

Main terminal box

Grounding for leads 5.2–25 mm² / 10–4 AWG

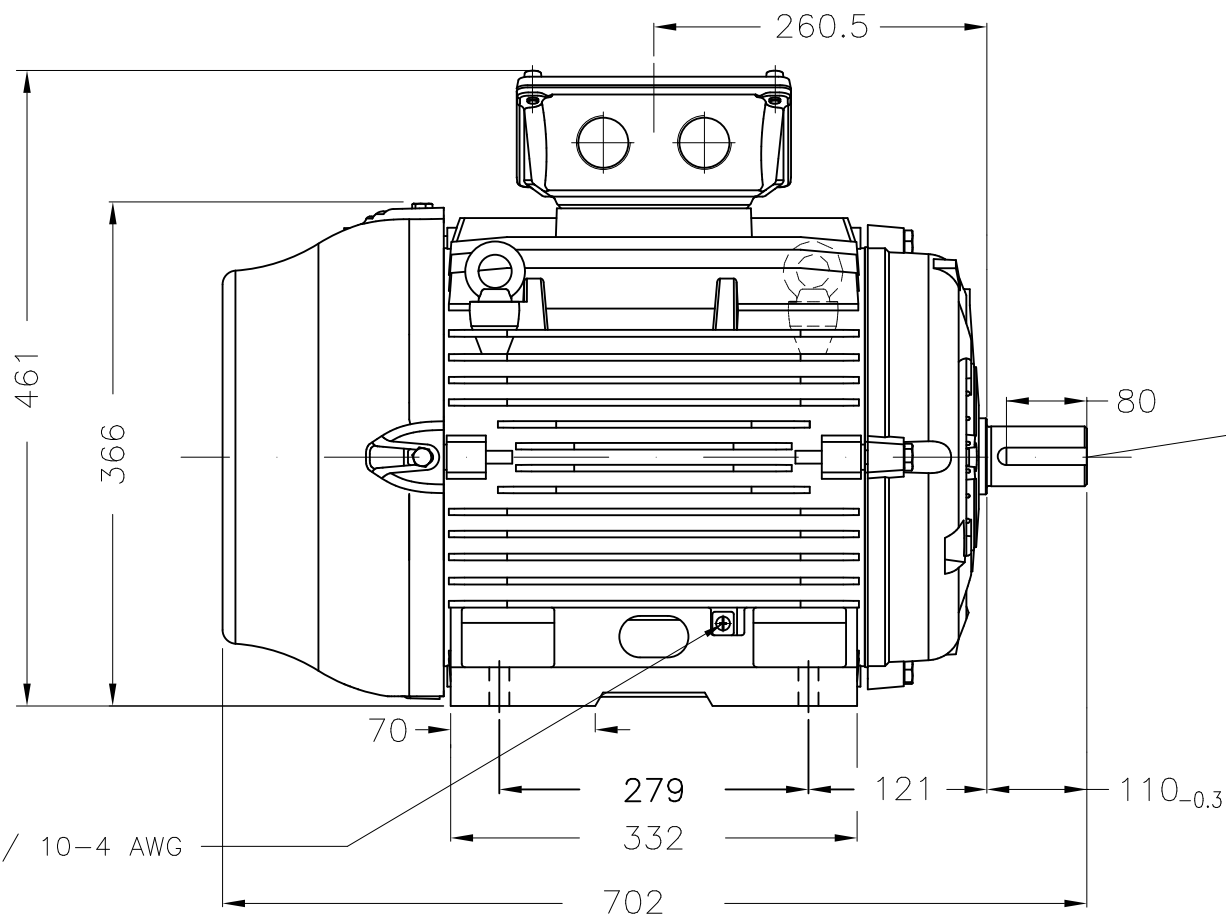

Center hole
DM16 WEG TBG12
(DIN 332)

Grounding for leads 5.2–25 mm² / 10–4 AWG

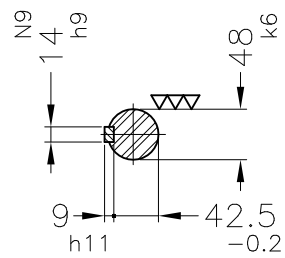

DE Shaft End

Color RAL 5009
Painting plan 205P
Mounting B3T

ECM	LOC	SUMMARY OF MODIFICATIONS	EXECUTED	CHECKED	RELEASED	DATE	VER
EXECUTED	USERADMIN	THREE PHASE W22 MOTOR - NON SPARKING ARP FRAME 180L IP55 TEFC WEG code: 12681753					
CHECKED							
RELEASED							
REL DT	24.07.2017	WMO Jaragua do Sul	Product Engineering	SHEET	1 / 1		

22 kW 04 Poles 50 Hz

A

WEG's property. Forbidden reproduction without previous authorization.



ZME A3