

Dimensional Drawing

Catalogue	Model	HP	Pole	kW	Rating	Voltage	Hz	RPM
PDH8004R	AEHE	800	4	597	Continuous	0 / 460 V	60	1800

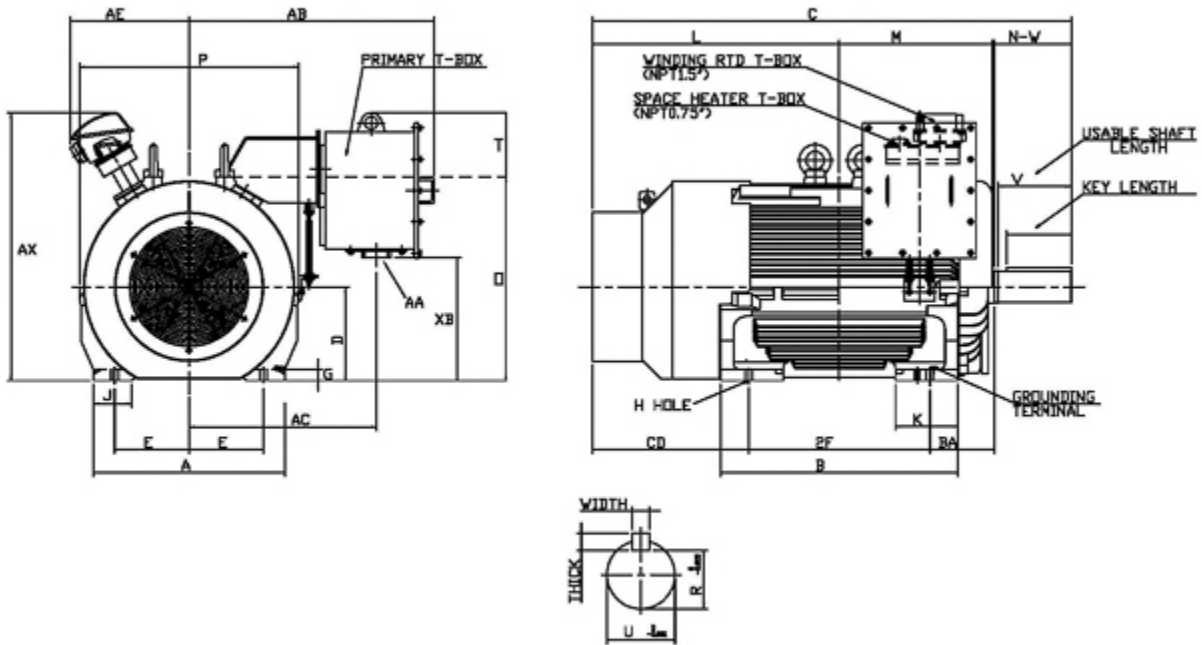

Frame Size	Mounting					A	B	C	CD	D	
	E	2F	2F2	H	BA						
5810C	11.5	36		1.13	10	29.55	44.1	81.81	23.93	14.5	
G	J	K	L	M	O	P	T	Key			Keyseat
1.7	5.9	9.65	41.93	27.2	31.45	33.85	9.45	Width	Thick	Length	R
								1.25	1.25	10	4.169
Terminal Housing				Aux Box		C/D Flange					
AA	AB	AC	XB	AE	AX	BB	AH	AK	BD	Aj	BF
2x 3 NPT	30.5	24.4	21.1	18.34	41.39						
Shaft Extension			Bearings		Approx. Weight Lbs	SPL dBA/3ft	Ins. Class	S.F.	Drive Method	Dimensions	
N-W	U	V	DE	NDE							
11.88	4.875	11.38	NU326C3	6322	7040	83	F	1.15	Belt Drive	Inches	

Technical Data Sheet

Motor Type: AEHE

Catalogue No: PDH8004R

Nameplate Information

HP	Pole	RPM	Frame	Voltage	Hz	Phase
800	4	1785	5810C	0 / 460	60	3
Enclosure	Ins. Class	Service Factor	Time Rating	NEMA Design	Rated Amb.	Rated Altitude
TEFC	F	1.15	Continuous	B	-40 to 40 °C	<3300 ft

Typical Performance

Efficiency (%)				Power Factor (%)		
Full Load		3/4 Load	1/2 Load	Full Load	3/4 Load	1/2 Load
Nom.	Min.					
95.6	94.8	95.4	94.0	90.5	89.0	84.0
Torque				Current (A)		
Full Load (lb-ft)	Locked Rotor (% FLT)	Pull Up (% FLT)	Break Down (% FLT)	No Load	Full Load	Locked Rotor
2352.94	90	90	200	0.0 / 150.0	865.8	6300
NEMA KVA Code	Inertia (WR ²)			Safe Stall Time (s)		Noise Level Sound Press. dB(A)
	Rotor (lb-ft ²)	NEMA Load (lb-ft ²)	Max. Allowable (lb-ft ²)	Cold	Hot	
0	536.000	2815.0	4222.5	24	18	83

VFD Duty Information

Speed Range			VFD		S.F.
Constant Torque	Variable Torque	Constant Power	Carrier	Type	
20-60Hz	3-60Hz	60-60Hz	≤ 5 kHz	VPWM or CPWM	0

Additional Information

Bearings		Approx. Weight
DE	NDE	lbs
NU326C3	6322	7040

Hazardous Locations Information

N/A
N/A
N/A
Temp Code (Sinewave / VFD) T3 (1.0 SF) / T2B