

Dimensões em mm
Dimensions in mm

THIS IS AN UPDATED REVISION, THE
PREVIOUS ONE MUST BE DISREGARDED.

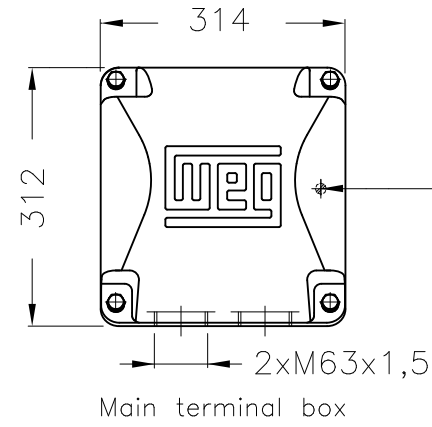

Grounding for leads 35–70 mm² / 1–2/0 AWG

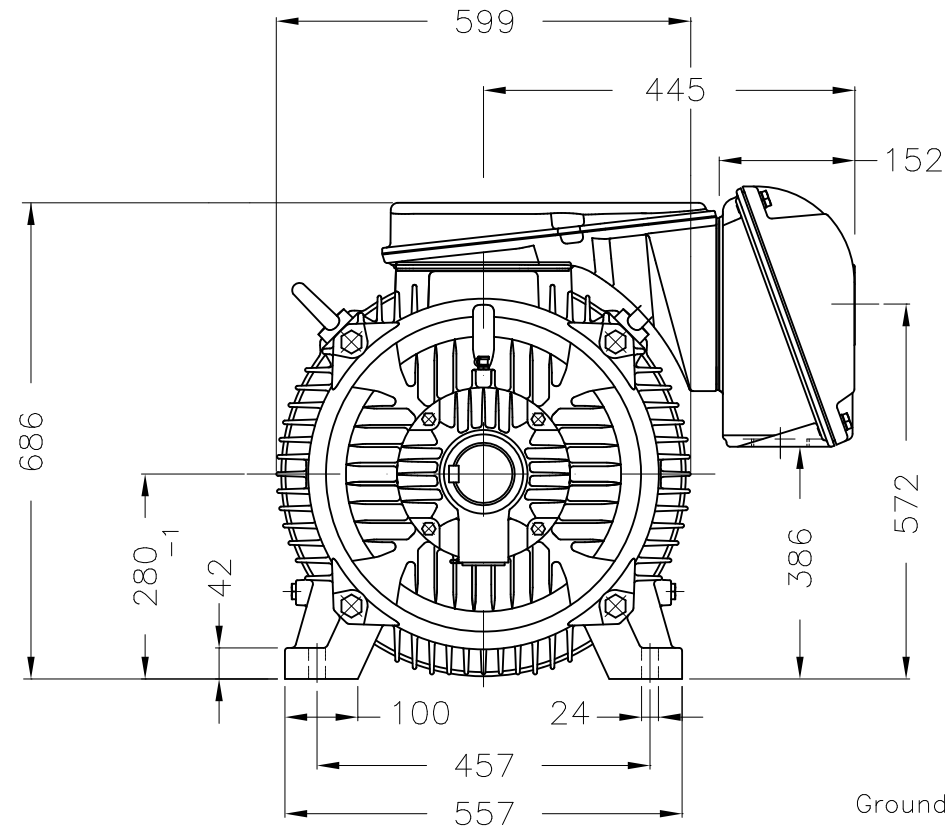
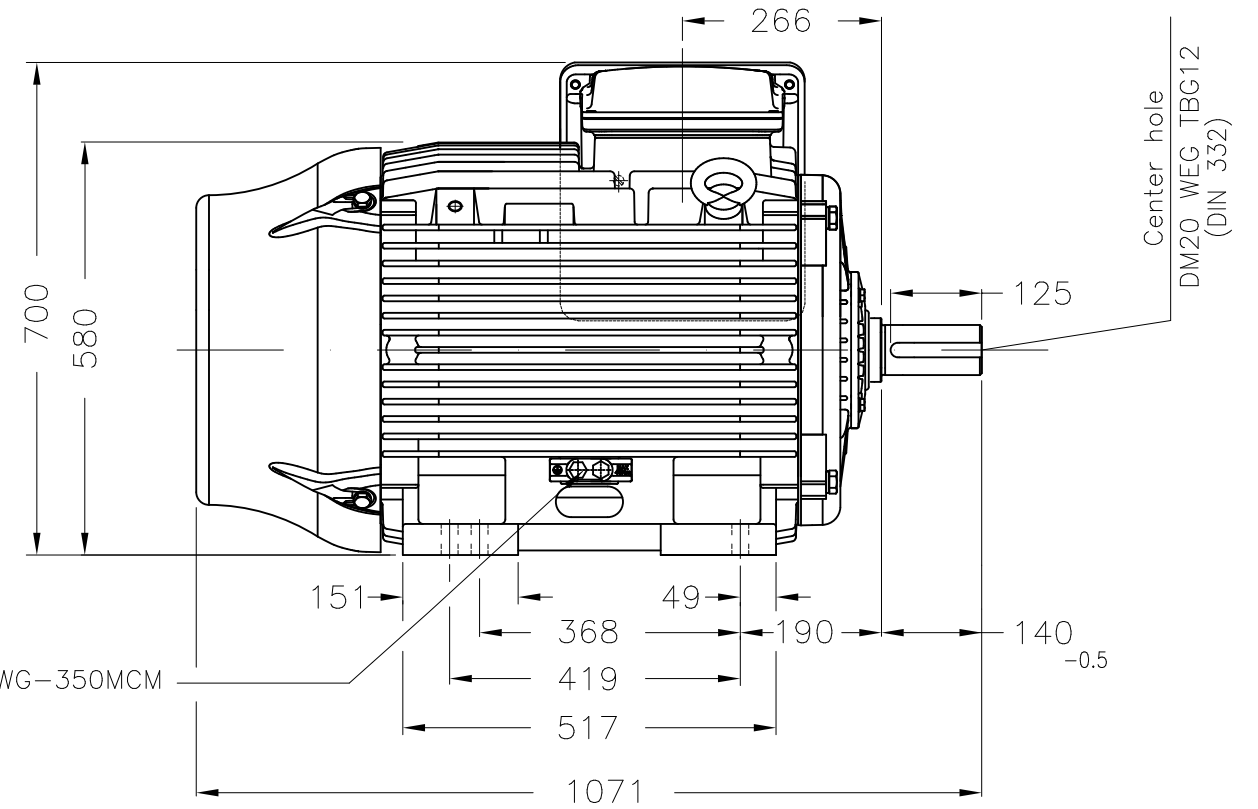

Grounding for leads 25–185 mm² / 3AWG–350MCM

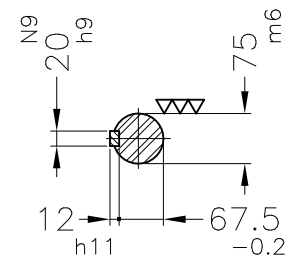

DE Shaft End

Color RAL 5009

Painting plan 203A

Mounting B3L(E)

ECM	LOC	SUMMARY OF MODIFICATIONS			EXECUTED	CHECKED	RELEASED	DATE	VER
EXECUTED	USERADMIN		THREE PHASE W22 TRU-METRIC PREMIUM EFF						
CHECKED			FRAME 280S/M IP55 TEFC						
RELEASED			WEG code: 11567531						
REL DT	24.07.2017	WMO	Jaragua do Sul	Product Engineering	SHEET	1 / 1			

125 HP 04 Poles 60Hz

A

