

Dimensional Drawing

Catalogue	Model	HP	Pole	kW	Rating	Voltage	Hz	RPM
XPE3008	AEHG_TK	300	8	224	Continuous	2300 / 4000 V	60	900

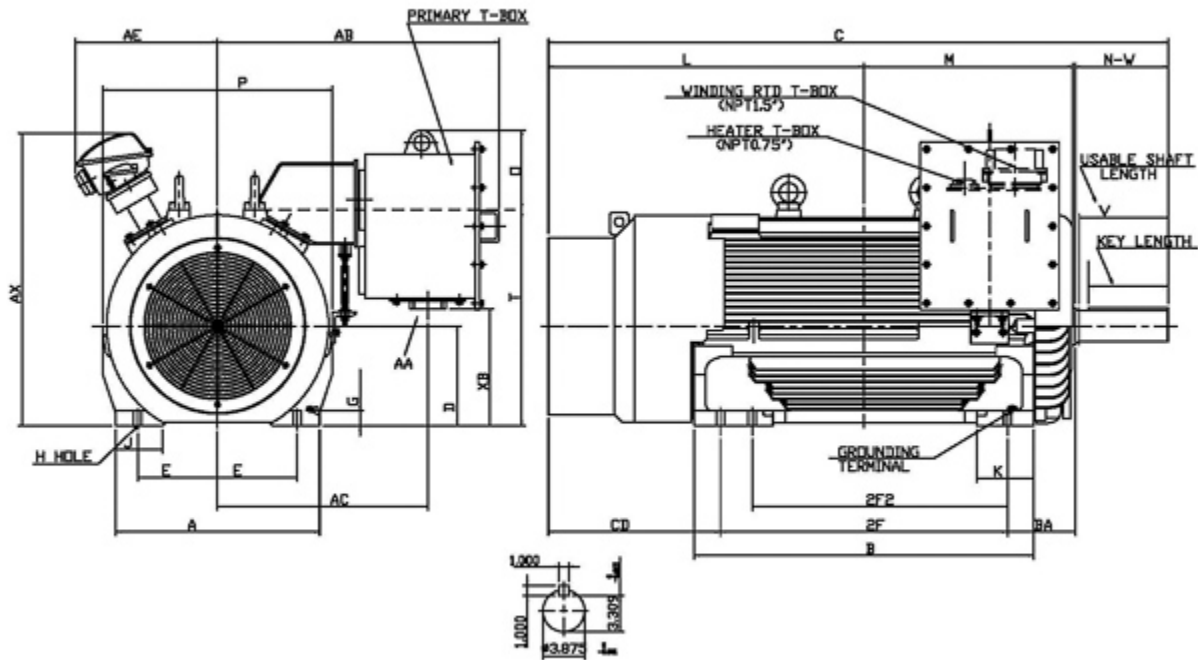

Frame Size	Mounting					A	B	C	CD	D	
	E	2F	2F2	H	BA						
5011B	10	36	32	0.94	8.5	25.6	42.5	77.69	21.57	12.5	
G	J	K	L	M	O	P	T	Key			Keyseat R
								Width	Thick	Length	
1.85	5.9	7.1	39.57	26.2	27.07	28.75	9.83	1	1	10	3.309
Terminal Housing			Aux Box			C/D Flange					
AA	AB	AC	XB	AE	AX	BB	AH	AK	BD	AJ	BF
2	35.28	26.37	14.67	17.83	36.67						
Shaft Extension			Bearings		Approx. Weight Lbs	SPL dBA/3ft	Ins. Class	S.F.	Drive Method	Dimensions	
N-W	U	V	DE	NDE							
11.62	3.875	11.12	6324	6320	4750	79	F	1.15	Direct Coupling	Inches	

Technical Data Sheet

Motor Type: AEHG_TK	Catalogue No: XPE3008
---------------------	-----------------------

Nameplate Information

HP	Pole	RPM	Frame	Voltage	Hz	Phase
300	8	890	5011B	2300 / 4000	60	3
Enclosure	Ins. Class	Service Factor	Time Rating	NEMA Design	Rated Amb.	Rated Altitude
TEFC	F	1.15	Continuous	B	-40 to 40 °C	<3300 ft

Typical Performance

Efficiency (%)				Power Factor (%)		
Full Load		3/4 Load	1/2 Load	Full Load	3/4 Load	1/2 Load
Nom.	Min.					
95.00	94.10	94.50	93.60	80.50	75.50	65.00
Torque				Current (A)		
Full Load (lb-ft)	Locked Rotor (% FLT)	Pull Up (% FLT)	Break Down (% FLT)	No Load	Full Load	Locked Rotor
1770.00	115	100	230	27.0 / 15.5	73.5 / 42.3	467 / 269
NEMA KVA Code	Inertia (WR ²)			Safe Stall Time (s)		Noise Level Sound Press. dB(A)
	Rotor (lb-ft ²)	NEMA Load (lb-ft ²)	Max. Allowable (lb-ft ²)	Cold	Hot	
G	255.000	6540	13082	20	14	79

VFD Duty Information

Speed Range			VFD		S.F.
Constant Torque	Variable Torque	Constant Power	Carrier	Type	
30-60Hz	3-60Hz	60-120Hz	≤ 5 kHz	VPWM or CPWM	1.0 Only

Additional Information

Bearings		Approx. Weight
DE	NDE	lbs
6324	6320	4750

Hazardous Locations Information

CSA Certified	
Class I, Div 2, Groups B, C & D Class I, Zone 2, Groups IIB+H2, IIB & IIA	
Temp Code (Sinewave / VFD)	T3 / N/A