

Dimensional Drawing

Catalogue	Model	HP	Pole	kW	Rating	Voltage	Hz	RPM
APH0604-841	AEHH8B	60	4	45	Continuous	460 V	60	1800

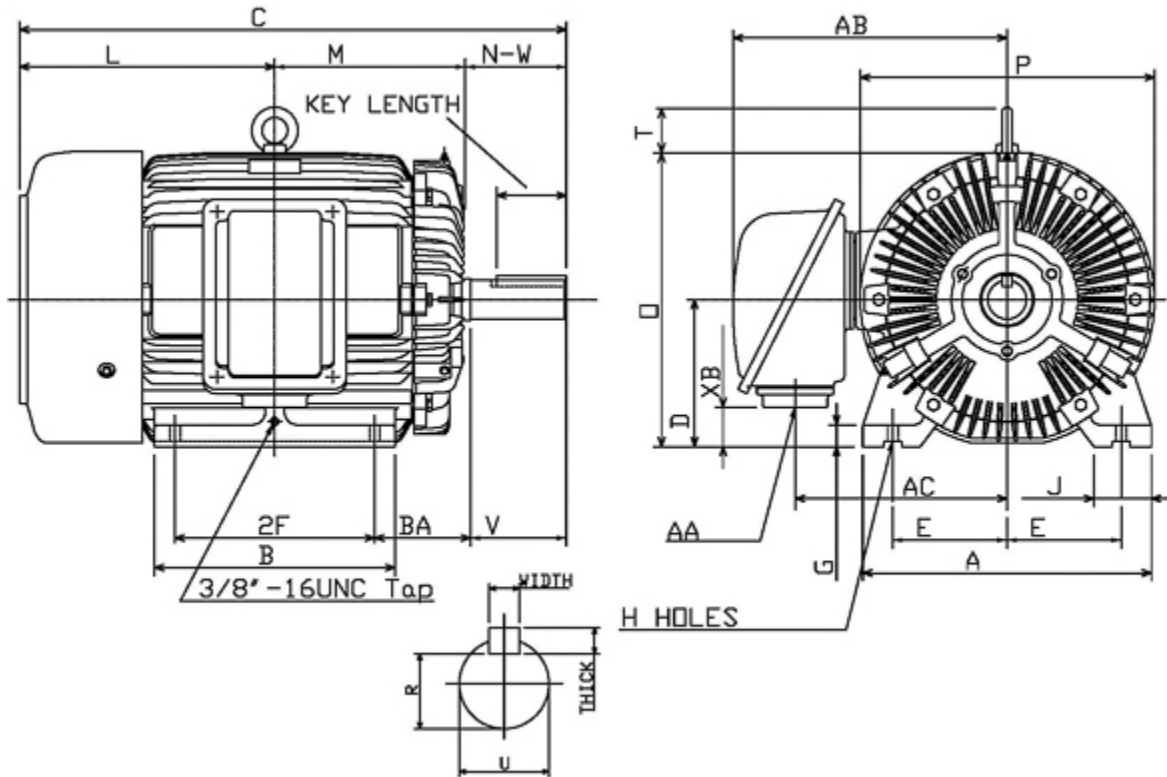

Frame Size	Mounting					A	B	C	CD	D	
	E	2F	2F2	H	BA						
364T	7	11.25		0.66	5.88	17.7	13.78	32.57		9	
G	J	K	L	M	O	P	T	Key			Keyseat
1.32	3.54		15.17	11.09	17.99	18.03	2.76	Width	Thick	Length	R
								0.625	0.625	4.28	2.021
Terminal Housing				Aux Box		C/D Flange					
AA	AB	AC	XB	AE	AX	BB	AH	AK	BD	AJ	BF
NPT3"	16.81	12.99	2.39								
Shaft Extension			Bearings		Approx. Weight Lbs	SPL dBA/3ft	Ins. Class	S.F.	Drive Method	Dimensions	
N-W	U	V	DE	NDE							
5.88	2.375	5.75	6313ZC3	6213ZC3	873	79	F	1.15	Direct Coupling / Belt Drive	Inches	

Technical Data Sheet

Motor Type: AEHH8B

Catalogue No: APH0604-841

Nameplate Information

HP	Pole	RPM	Frame	Voltage	Hz	Phase
60	4	1775	364T	460	60	3
Enclosure	Ins. Class	Service Factor	Time Rating	NEMA Design	Rated Amb.	Rated Altitude
TEFC	F	1.15	Continuous	B	-40 to 40 °C	<3300 ft

Typical Performance

Efficiency (%)				Power Factor (%)		
Full Load		3/4 Load	1/2 Load	Full Load	3/4 Load	1/2 Load
Nom.	Min.					
95.0	94.1	95.0	94.5	86.5	83.0	75.5
Torque				Current (A)		
Full Load (lb-ft)	Locked Rotor (% FLT)	Pull Up (% FLT)	Break Down (% FLT)	No Load	Full Load	Locked Rotor
177.50	200	155	240	21.2	68.4	435
NEMA KVA Code	Inertia (WR ²)			Safe Stall Time (s)		Noise Level Sound Press. dB(A)
	Rotor (lb-ft ²)	NEMA Load (lb-ft ²)	Max. Allowable (lb-ft ²)	Cold	Hot	
G	12.229	275	583	17	12	79

VFD Duty Information

Speed Range			VFD		S.F.
Constant Torque	Variable Torque	Constant Power	Carrier	Type	
6-60Hz	3-60Hz	60-90Hz	≤ 5 kHz	VPWM or CPWM	1.0 Only

Additional Information

Bearings		Approx. Weight
DE	NDE	lbs
6313ZC3	6213ZC3	873

Hazardous Locations Information

CSA Certified	
Class I, Div 2, Groups B, C & D Class I, Zone 2, Groups IIB+H2, IIB & IIA	
Temp Code (Sinewave / VFD)	T3C / T3